

**CITY OF ISLE OF PALMS, SOUTH CAROLINA
REQUEST FOR BIDS (RFB) 2022-02
CONSTRUCTION OF 34A BEACH ACCESS BOARDWALK**

The City of Isle of Palms is seeking bids from qualified general contractors for the construction of a 663' by 6' beach access boardwalk. The boardwalk is used as a beach access for persons with disabilities and must be ADA compliant. This request is being made and awarded pursuant to the City's procurement ordinance. The City reserves the right to reject any and all bids and to waive irregularities.

Bids should be submitted to the following:

Matt Simms
Zoning Administrator
City of Isle of Palms
1207 Palm Boulevard
Post Office Box 508
Isle of Palms, South Carolina 29451

Deadline for Questions

The deadline for questions is 5:00 p.m., Eastern Time, Friday, July 29th, 2022. Bidders should send questions regarding this Request for Bids to Matt Simms, Zoning Administrator, in writing or email to msimms@iop.net. Questions received before this deadline will be answered via addendum posted on the City's website at <http://www.iop.net/requests-for-bids-proposals>. Questions received after this deadline will not be answered.

If an addendum is issued, Bidders must acknowledge receipt of the addendum with their bid.

Deadline for Submissions

The deadline for submission is 10:00 a.m., Eastern Time, Friday, August 12th, 2022. Bids will be received at the front desk of the Building Department, on the first floor of 1207 Palm Boulevard, Isle of Palms, South Carolina 29451 in a sealed envelope. Sealed envelopes must be clearly marked "RFB 2022-02, 34A Beach Access Boardwalk" and include one (1) hard copy and one (1) electronic copy saved to a USB flash drive. It will be the responsibility of the bidders to verify receipt by the City.

Bids may be delivered by hand or by mail, but no bid shall be considered which is not actually received by the City at the place, date and time appointed by the City and the City shall not be responsible for any failure, misdirection, delay or error resulting from the selection by any bidder of any particular means of delivery.

Proprietary and/or Confidential Information: Your bid is a public document under the South Carolina Freedom of Information Act (FOIA), except as to information that may be treated as confidential as an exception to disclosure under the FOIA. If you cannot agree to this standard, please do not submit your bid. All information that is to be treated as confidential and/or proprietary must be CLEARLY identified, and each page containing confidential and/or proprietary information, in whole or in part, must be stamped and/or denoted as CONFIDENTIAL, in bold, in a font of at least 12-point type, in the upper right-hand corner of the page. All information not so denoted and identified will be subject to disclosure by the City.

Bidders acknowledge and agree that the City will not be liable for any costs, expenses, losses, damages (including damages for loss of anticipated profit) or liabilities incurred by the respondent or any member of the respondent's organization as a result of, or arising out of, submitting a bid, negotiating changes, or due to the City's acceptance or non-acceptance of the bid or the rejection of any and all bids. Bidders are responsible for submission of accurate, adequate and clear descriptions of the information requests. Neither issuance of the RFB, preparation and submission of a response, nor the subsequent receipt and evaluation of any response by the City of Isle of Palms will commit the City to award a contract to any respondent even if all the requirements in the RFB have been met.

Bidders must have or be able to procure an Isle of Palms Business License.

Contractors considering submission under this RFB will be expected to have read and be prepared to enter into the attached contract, which is a part of this RFB. The City of Isle of Palms reserves the right to accept or reject any and all bids, or any parts thereof; to waive irregularities or informalities in any bid received to allow the bid to be considered; to negotiate terms and conditions with Bidders; and to select a Bidder or to cancel in whole or in part this RFB, if it is in the best interest of the City to do so. Those bids determined not to be in compliance with provisions of this RFB and the applicable laws and or regulations will not be processed.

By signing its bid, Bidder certifies that it will comply with the applicable requirements of Title 8, Chapter 14 of the South Carolina Code of Laws and agrees to provide the City upon request any documentation required to establish either: (a) that Title 8, Chapter 14 is inapplicable both to Bidder and its subcontractors or sub-subcontractors; or (b) that Bidder and its subcontractors or sub-subcontractors are in compliance with Title 8, Chapter 14. Pursuant to Section 8-14-60, "A person who knowingly makes or files any

false, fictitious, or fraudulent document, statement, or report pursuant to this chapter is guilty of a felony and, upon conviction, must be fined within the discretion of the court or imprisoned for not more than five years, or both.” Bidder agrees to include in any contracts with its subcontractors language requiring its subcontractors to (a) comply with the applicable requirements of Title 8, Chapter 14 and (b) include in their contracts with subcontractors, language requiring the sub-subcontractors to comply with the applicable requirements of Title 8, Chapter 14.

Scope of Work

A site visit to the Isle of Palms 34A beach access is strongly suggested prior to submitting a bid.

The Scope of work for the project includes, but is not limited to the following:

1. Regrade and compact surfaces to allow new improvements to match the elevations, as detailed on the attached plans, dated 6/3/22 by Jody Furman.
2. Construction and striping of two asphalt ADA compliant parking spaces adjacent to Palm Boulevard, as detailed on the attached plans. Install two new handicap parking signs.
3. Construction of a pervious concrete sidewalk, measuring 353 feet by 6 feet, as detailed on the attached plans.
4. Construction of a wooden boardwalk, including Ipé decking, measuring 310 feet by 6 feet, as detailed on the attached plans.
5. Lower the existing telecommunications utility vault in the right-of-way to be flush with the top of the new sidewalk or shift the vault to not conflict with the sidewalk.
6. Shift all existing signage to not conflict with the new improvements.

The chosen contractor shall provide all materials, equipment, supplies, freight, state sales tax, labor and supervision as necessary.

Time is of the essence for this project and all work associated with this RFB must be completed within 120 days of the issuance of the Notice to Proceed.

Bid Format

In responding to this request, contractors should provide a price quote for the scope of work to accomplish this work on the attached "BID FORM". Contractors should also provide a cost breakdown of the scope of work on the "ITEMIZED COST" form.

If any addenda(um) are issued, the contractor must acknowledge reviewing the addenda(um) by listing them on the BID FORM.

In addition to submitting the completed BID FORM, contractors submitting bids should provide examples of experience with similar projects. Provide a brief description of similar projects of comparable size and complexity for which the Bidder provided services within the past five (5) years. Limit information to no more than five (5) projects.

A performance bond for 100% of the construction contract amount will be required.

All such descriptions should include:

1. Project location.
2. Renovation and/or Replacement.
3. Description of original project budget versus actual cost.
4. Name and contact information for a reference with knowledge of the Bidder's work on the specified project.

Provide the Contractor(s) and if possible the names and bids of all sub-consultants that will be part of the Bidder's Team and identify the specific work the sub-consultant will perform. Once the City issues a contract, no change in sub-consultants assigned to the project will be permitted without prior written approval from the City.

Evaluation Criteria

The City will evaluate bids based on the factors outlined within this RFB and the City's procurement ordinance, which shall be applied to all eligible, responsive bids in selecting the successful contractor. The City reserves the right to disqualify any bid from a bidder it deems as non-responsive and/or non-responsible. The City reserves the right to make such investigations of the Bidders as it deems appropriate.

Award of any contract may be made without discussion with Bidders after bids are received. The City reserves the right to cease contract negotiations if it is determined that the Bidder cannot perform the services specified in their response.

Recommendation of award for contract will be made based not only on price, which is an important factor, but also on quality of bid, qualifications, experience, technical

expertise, references and ability to execute the work. After careful evaluation, the Public Works Committee will make a recommendation to City Council for award of a contract

BID FORM

BID OF: _____

(Contractor)

BID TO: The City of Isle of Palms

(Owner)

PROJECT NAME: 34A Beach Access

PROJECT NUMBER: RFB 2022-02

BID DATE: _____

BASE BID AGREEMENT

The undersigned, having examined all the Bidding Documents, including all Addendum(a) as follows:

shall execute the entire Work in the Bidding Documents described as the Base Bid for the lump sum of:

_____ Dollars

(\$ _____) which sum is hereafter called the BASE BID.

ITEMIZED COSTS (sum of each item should total BASE BID amount)

1. Grading and compacting.
_____ Cost
2. Two asphalt ADA parking areas.
_____ Cost
3. A 353-foot by 6-foot pervious concrete sidewalk.
_____ Cost
4. A 310-foot by 6-foot Ipé boardwalk.
_____ Cost

BASE BID _____

DATE FOR COMMENCEMENT AND SUBSTANTIAL COMPLETION

The Date for Commencement shall be established in the Notice to Proceed. The Contractor shall not incur any expense until the contract has been awarded. An award requires that either the Contract be signed by both the awarding authority and the contractor or a Notice to Proceed is executed.

All work for additions shall be substantially completed (as evidenced by the date on the CERTIFICATE OF SUBSTANTIAL COMPLETION) within: ONE-HUNDRED TWENTY (120) calendar days from the date set forth in the NOTICE TO PROCEED, subject to adjustments as provided in the Contract Documents.

Final completion of all work shall be performed within: THIRTY (30) calendar days from the scheduled contract time for substantial completion, subject to adjustments as provided in the Contract Documents.

The undersigned further agrees that from the compensation to be paid, the owner may retain as liquidated damages the sum of one thousand dollars (\$1,000) for each calendar day the actual contract time for Substantial Completion for the project exceeds the specified or adjusted contract time for Substantial Completion as provided in the Contract Documents.

Contractor the sum of _____ (\$ _____) Dollars, payable upon completion of the Project.

3. CHANGE ORDERS. The City has the right to require alterations or changes ("Change Orders") to the Project and in such case Contractor agrees to make such alterations or changes; provided, however, that the details and additional cost or credit of such Change Order must be agreed to by the City and Contractor in writing prior to the commencement of the Change Order.

4. COMPLETION SCHEDULE. TIME IS OF THE ESSENCE. Contractor agrees to complete the Project within one-hundred twenty (120) days from the date of this Agreement. Provided, however, that if performance by the Contractor is delayed for reasons or causes beyond the control of Contractor (including but not limited to, acts of God, weather conditions, site conditions, labor or material shortages, delays caused by City, and casualty losses) the Project completion date shall be extended accordingly.

5. INSURANCE. Contractor agrees to maintain comprehensive general liability insurance coverage on the work under the Project in an amount not less than \$1,000,000.00 per person, \$2,000,000.00 per claim, and \$250,000.00 per claim for property damage. Contractor also agrees to maintain worker's compensation coverage on its employees as required by the State of South Carolina workers' compensation laws. All insurance coverage required hereunder shall be with companies approved in advance by City, who shall be named as an additional insured on all such policies. Proof of such insurance shall be provided to City prior to commencement of any work by Contractor.

6. PERMITS, FEES AND LICENSES. Contractor agrees to apply for, obtain and pay for all permits, fees, licenses and inspections by governmental agencies necessary for the Contractor's proper performance and completion of the Project, including, but not limited to, a City business license.

7. INDEMNIFICATION. Contractor agrees to hold harmless and indemnify City and its officers, agents and employees from and against any loss or damage, including all reasonable attorney's fees and expenses, incurred as a result of any and all claims, demands, causes of action, suits, judgments, fines or penalties (including but not limited to all fees and expenses incurred as a result of death or injury to persons or for loss of or damage to property) arising out of or in connection with Contractor's performance of the work under this Agreement.

8. SITE INVESTIGATION. Contractor acknowledges that Contractor has had the opportunity to inspect the service areas, has determined the nature of the work and the difficulties and facilities attending performance of the work, and all other matters which Contractor contemplates may in any way affect the work under this Agreement.

9. **BINDING ARBITRATION.** Any dispute or controversy arising under or in connection with this Agreement shall be submitted to binding arbitration in accordance with the requirements of the South Carolina Uniform Arbitration Act as then in effect ("SCUAA"). All arbitration proceedings shall be conducted in Charleston County, South Carolina. The arbitrators shall be selected as provided in the SCUAA, and the arbitrators shall render a decision on any dispute within ninety (90) days after the last of the arbitrators has been selected. If any party to this Agreement fails to select an arbitrator with regard to any dispute submitted to Arbitration under this Section within thirty (30) days after receiving notice of the submission to arbitration of such dispute, then the other party or parties shall select an arbitrator for such nonselecting party, and the decision of the arbitrators shall be final and binding upon all the parties to the dispute, their personal representatives, legal representatives, heirs, successors and assigns. The prevailing party in any such proceeding shall be entitled to reimbursement by the losing party, in addition to any damages awarded, for all reasonable costs and expenses, including attorney's fees, incurred in any such proceeding, including all trial and appellate levels. Nothing contained in this Section shall preclude either party from seeking injunctive relief through a court of competent jurisdiction in connection with the Arbitration, and the prevailing party shall also be entitled to reimbursement by the losing party for all reasonable fees and costs, including attorney's fees, incurred in the proceedings seeking injunctive relief.

10. **BREACH.**

A. In the event that either party breaches any provision of this Agreement, and the same continues for a period of seven (7) days after receipt of written notice thereof, then the nonbreaching party may exercise any and all remedies at law or in equity regarding the breach of this Agreement. Without prejudice to any other rights or remedies available for the said breach, the non-breaching party may terminate this Agreement and cease further performance under this Agreement.

B. Unless authorized by this Agreement, if the Contractor completely ceases work on the Project for a period of fifteen (15) days, or defaults or persistently fails or neglects to carry out the Project, the City may, after seven (7) days' written notice to the Contractor, complete the Project and if the unpaid balance of the contract price exceeds the City's actual cost of completing the Project, such excess shall be paid to the Contractor, but if such expense exceeds the unpaid balance, the Contractor shall pay the difference to the City.

11. **EFFECT OF WAIVER OR CONSENT.** A waiver or consent, express or implied, to or of any breach or default by a party in the performance of its obligations under this Agreement is not a consent or waiver to or of any other breach or default in the performance by that party of the same or any other obligations of that party with respect

to this Agreement. Failure on the part of a party to complain of any act of the other party or to declare a party in default with respect to this Agreement, irrespective of how long that failure continues, does not constitute a waiver by that party of its rights with respect to that default until the applicable statute-of-limitation period has run.

12. SUB-CONTRACT OR ASSIGNMENT. Contractor agrees not to enter into any subcontracts or assignments pertaining to the performance of all or any part of this Agreement, either voluntarily or by operation of law, without prior written approval of City.

13. BINDING AGREEMENT. This Agreement shall be binding upon and inure to the benefit of the parties hereto and their respective successors and permitted assigns.

14. GOVERNING LAW; SEVERABILITY. This Agreement is governed by and shall be construed and interpreted in accordance with the laws of the State of South Carolina. If any provision of this Agreement is held invalid or unenforceable to any extent by a court of competent jurisdiction, the remainder of this Agreement is not affected thereby and that provision shall be enforced to the greatest extent permitted by law.

15. ENTIRE AGREEMENT. This Agreement constitutes the entire agreement between the parties hereto relating to the subject matter hereof, and supersedes and nullifies all prior or contemporaneous contracts, agreements, understandings or representations, whether oral or written, which are not expressly stated in this agreement. Neither party is relying upon any representation not expressly contained herein. This Agreement may be amended and modified from time to time only upon the written mutual consent of City and Contractor.

16. SECTION HEADINGS. The headings of Sections or paragraphs used in this Agreement have been inserted for convenience only and are not to be used in determining the contents contained herein.

IN WITNESS WHEREOF, the City and Contractor have hereunto set their hands and seals, by and through the undersigned officers, as of the day and year first above written.

WITNESS:

Contractor:

(#1 as to Contractor)

By: _____

(#2 as to Contractor)

Title: _____

The City of Isle of Palms, S.C.:

(#1 as to City)

By: _____

(#2 as to City)

Title: _____

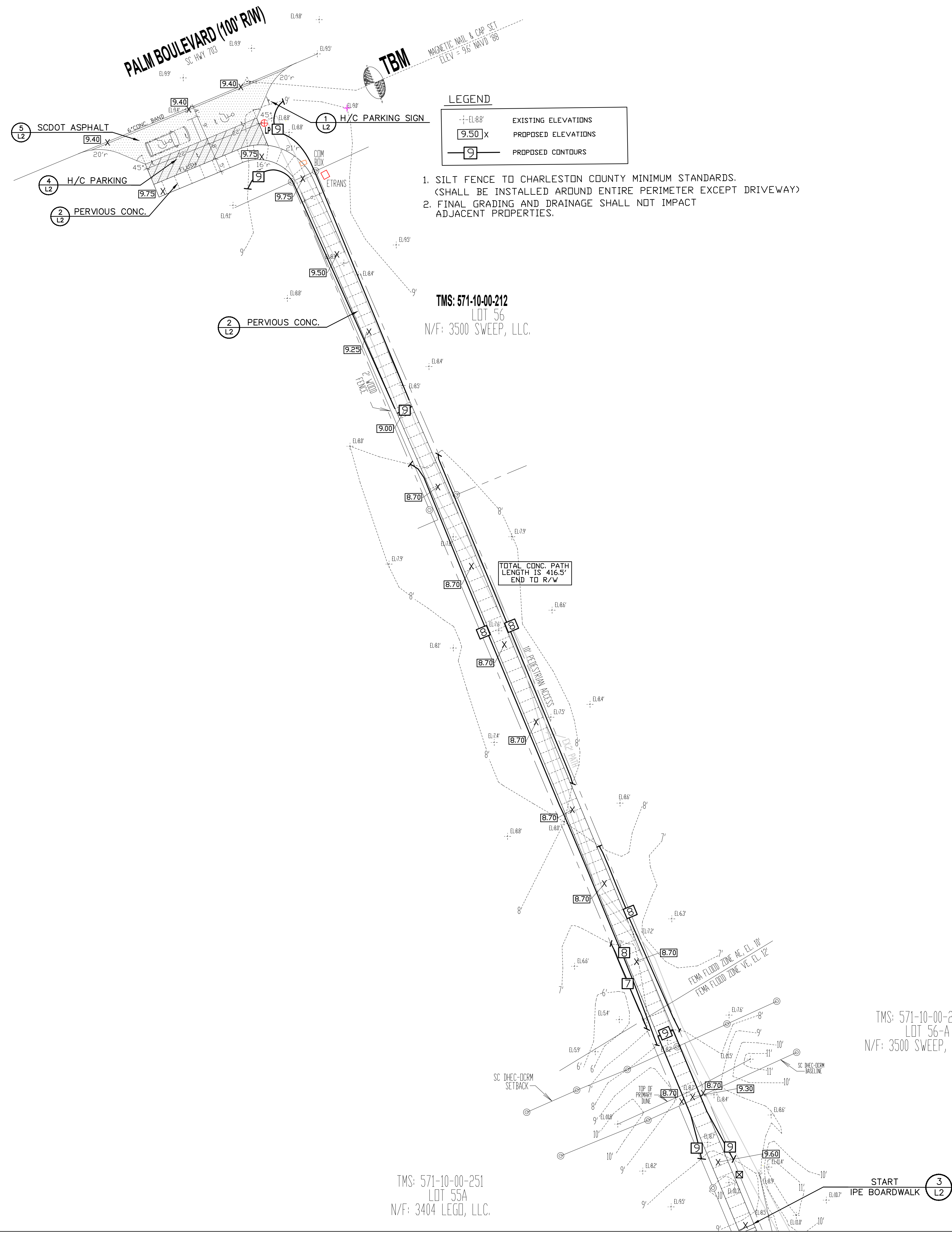

The South Carolina STATE LAW requires that excavators give a 72-Hour notice, (3 working days excluding weekends and holidays), for the locators to get out to mark the area. After a ticket has been processed, you will know when you are legally free to proceed with the digging work and which utilities in the area P.U.P.S. will be notifying for you. Any utilities that P.U.P.S. does not notify, you will be responsible for notifying directly. The Utility Companies ask that you leave a 2 1/2 feet margin on each side of a marked utility line. Also note that your request is good for 15 working days after it has been processed by our system.

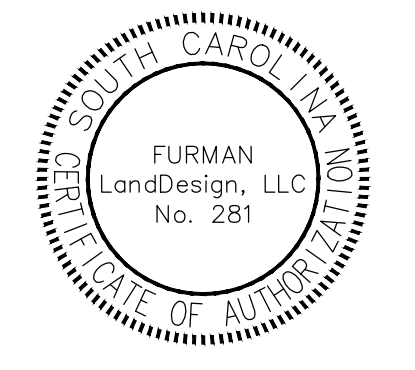

34A BEACH ACCESS
PALM BLVD.
CITY OF ISLE OF PALMS

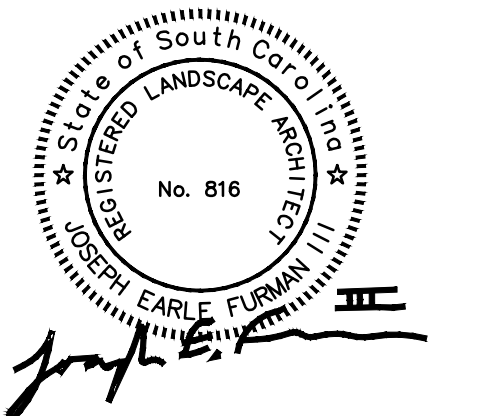

Revision:	Date:
·	12/8/21
·	5/18/22
·	6/3/22
·	

SITE PLAN
L1

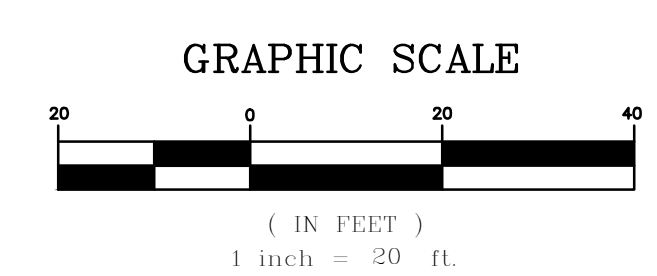

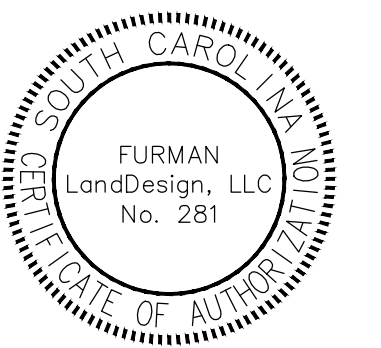

34A BEACH ACCESS
PALM BLVD.
CITY OF ISLE OF PALMS

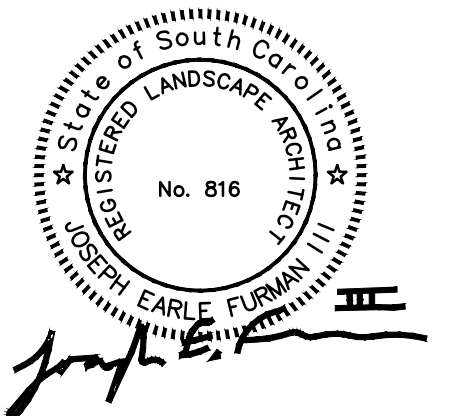

Revision:	Date:
·	12/8/21
·	5/18/22
·	6/3/22
·	

SITE PLAN
L2



TMS: 571-10-00-251
LOT 55A
N/F: 3404 LEGD, LLC.

TMS: 571-10-00-252
LOT 56-A
N/F: 3500 SWEEP, LLC.

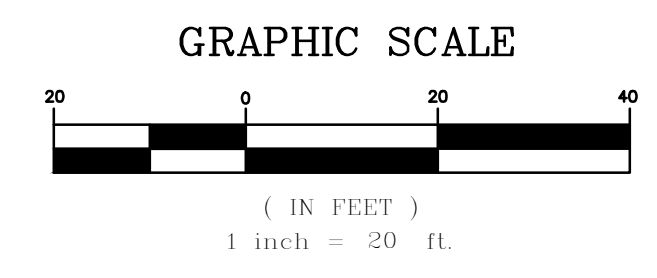

The South Carolina STATE LAW requires that excavators give a 72-Hour notice, (3 working days excluding weekends and holidays), for the locators to get out to mark the area. After a ticket has been processed, you will know when you are legally free to proceed with the digging work and which utilities in the area. P.U.P.S. will be notifying for you. Any utilities that P.U.P.S. does not notify, you will be responsible for notifying directly. The Utility Companies ask that you leave a 2 1/2 feet margin on each side of a marked utility line. Also note that your request is good for 15 working days after it has been processed by our system.

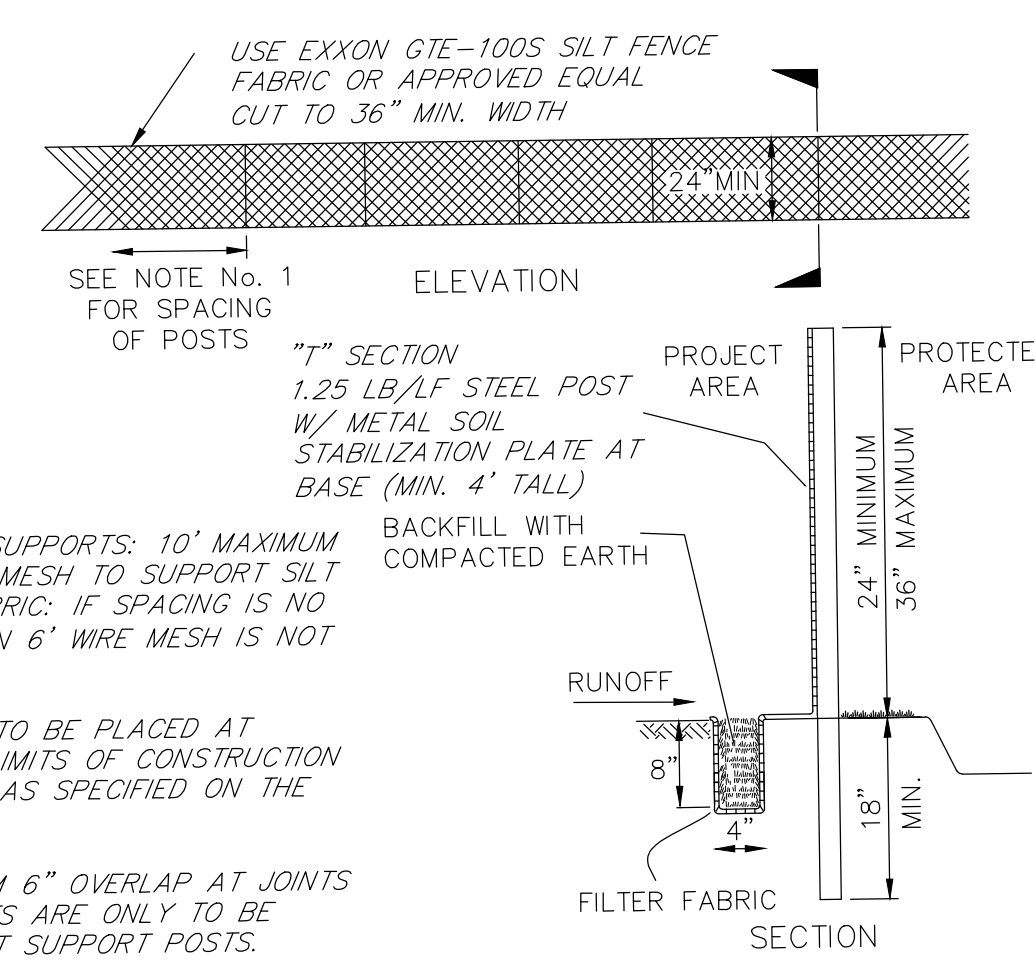

- NOTES:
1. SPACE SUPPORTS: 10' MAXIMUM WITH WIRE MESH TO SUPPORT SILT FENCE FABRIC. IF SPACING IS NO MORE THAN 6' WIRE MESH IS NOT REQUIRED.
 2. FENCE TO BE PLACED AT EXTREME LIMITS OF CONSTRUCTION AREA, OR AS SPECIFIED ON THE SITE PLAN.
 3. MINIMUM 6" OVERLAP AT JOINTS AND JOINTS ARE ONLY TO BE PLACED AT SUPPORT POSTS.
 4. DOUBLE ROW OF FENCING REQUIRED AROUND ALL WETLANDS OR OTHER WQS.

TYPICAL SILT FENCE
NOT TO SCALE

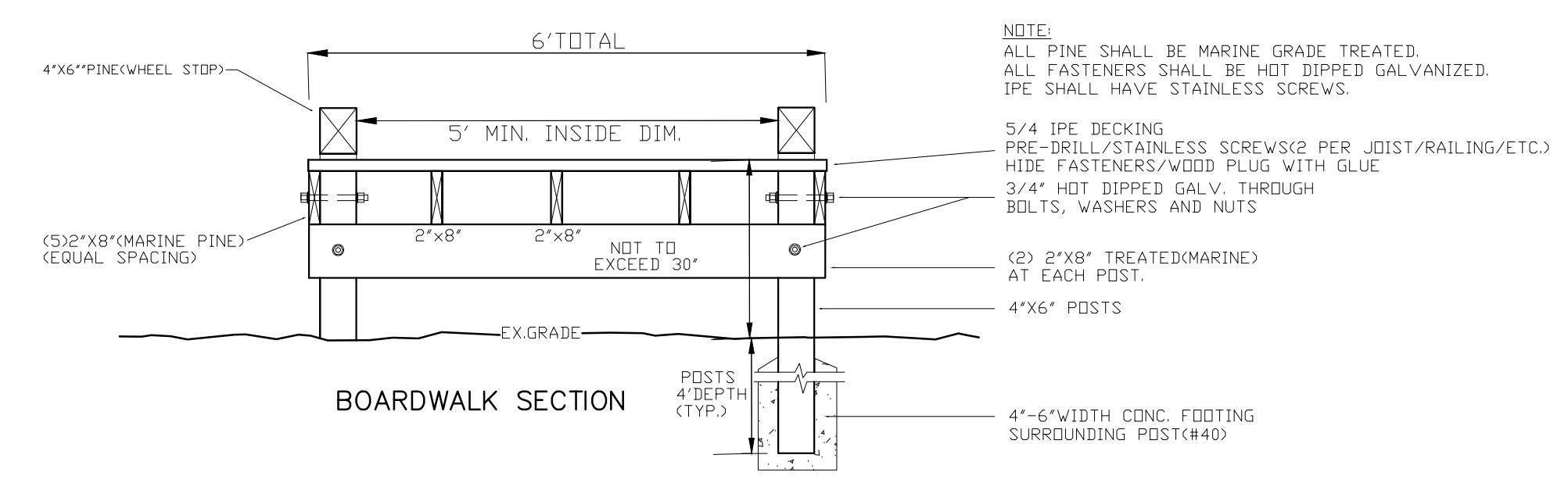

BOARDWALK
SCALE: N.T.S.

3
L3

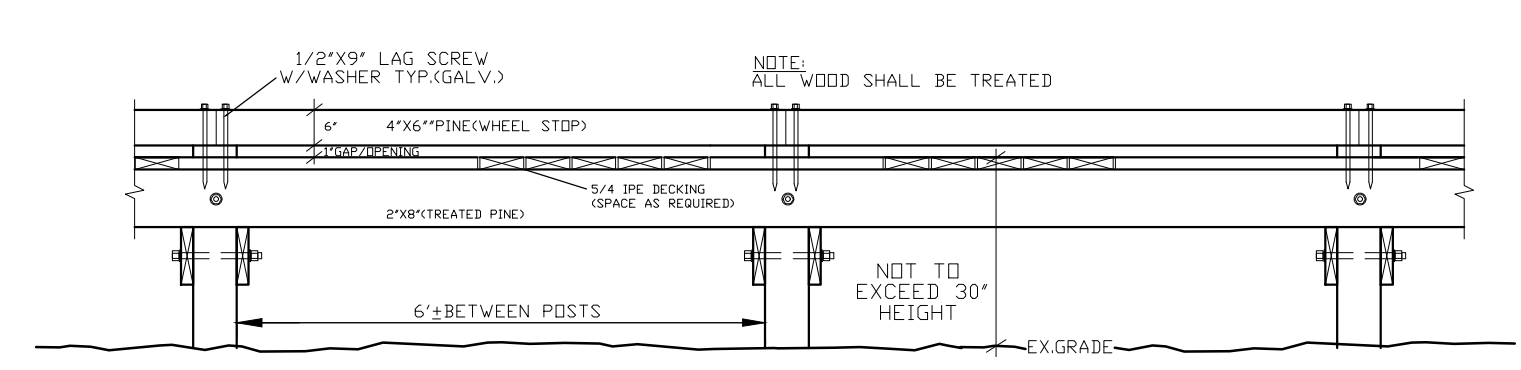

- NOTES REGARDING PARKING LOT SIGNAGE:
- 1) THE CONTRACTOR SHALL FURNISH AND INSTALL "HANDICAPPED PARKING" SIGNS WITH IDENTIFYING HANDICAPPED SYMBOL AT ALL HANDICAPPED PARKING SPACES. SIGNS SHALL BE 12"x18", 0.080 ALUMINUM WITH BAKED ENAMEL FINISH. SIGNS SHALL HAVE WHITE LETTERING ON BLUE BACKGROUND, WITH INSTALLATION AS SHOWN ON THE DETAIL SHEET. SIGNS SHALL CONFORM TO FEDERAL HIGHWAY ADMINISTRATION AND/OR SCDHPT SPECIFICATIONS. INCLUDE "VAN ACCESSIBLE" SIGNAGE WHERE APPLICABLE.

- NOTES REGARDING PARKING LOT STRIPING:
- 1) ALL PARKING LOT STRIPING SHOWN SHALL BE PERFORMED BY THE CONTRACTOR USING WHITE TRAFFIC MARKING PAINT UNLESS NOTED OTHERWISE BELOW. PAINT SHALL BE SHERWIN-WILLIAMS "PRO-MAR" TRAFFIC MARKING PAINT OR GLIDDEN TRAFFIC PAINT AND SHALL BE APPLIED IN TWO COATS AND IN STRICT ACCORDANCE WITH THE MANUFACTURER'S INSTRUCTIONS.
 - 2) ITEMS TO BE PAINTED WHITE INCLUDE: PARKING STALLS; DIRECTIONAL ARROWS OF SIZE AND LOCATIONS INDICATED; STOP BARS; AND STRIPED ISLANDS.
 - 3) ITEMS REQUIRING YELLOW PAINT INCLUDE RAISED DIVIDERS AND/OR MEDIANS; ALL SITEWORK PROTECTIVE GUARD POSTS BEYOND (5) FIVE FEET OF THE BUILDING; STEEL PIPE BASE OF HANDICAP PARKING SIGNS; HANDICAP RAMPS.
 - 4) ITEMS REQUIRING BLUE PAINT INCLUDE HANDICAP PARKING STALLS AND SYMBOLS; ALL STRIPED ISLANDS ADJACENT TO HANDICAP PARKING SPACES; AND ALL PEDESTRIAN CROSSING AREAS.
 - 5) SEE ARCHITECTURAL PLANS FOR ADDITIONAL STRIPING REQUIREMENTS.

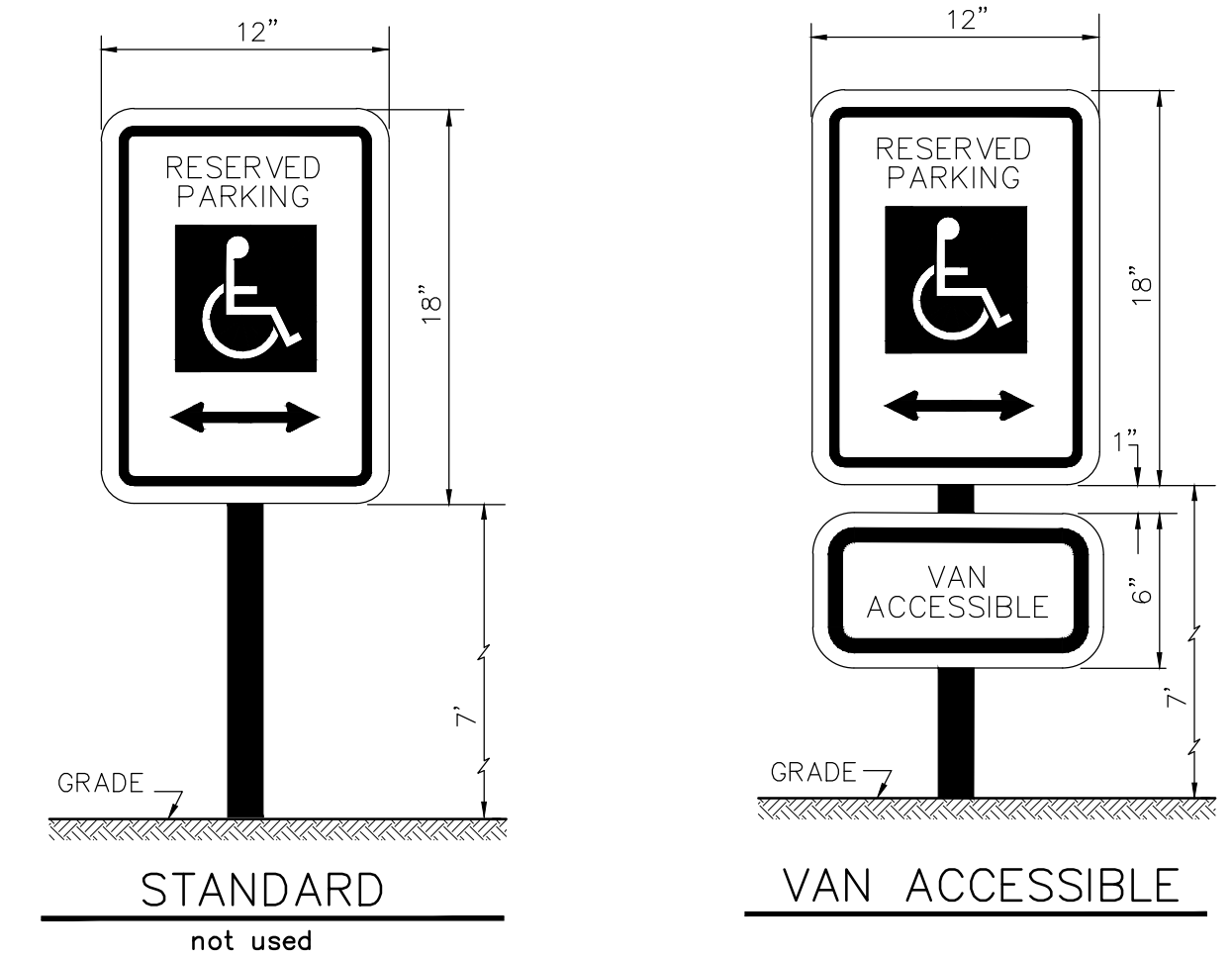

HANDICAPPED PARKING SIGN
NOT TO SCALE

1
L3

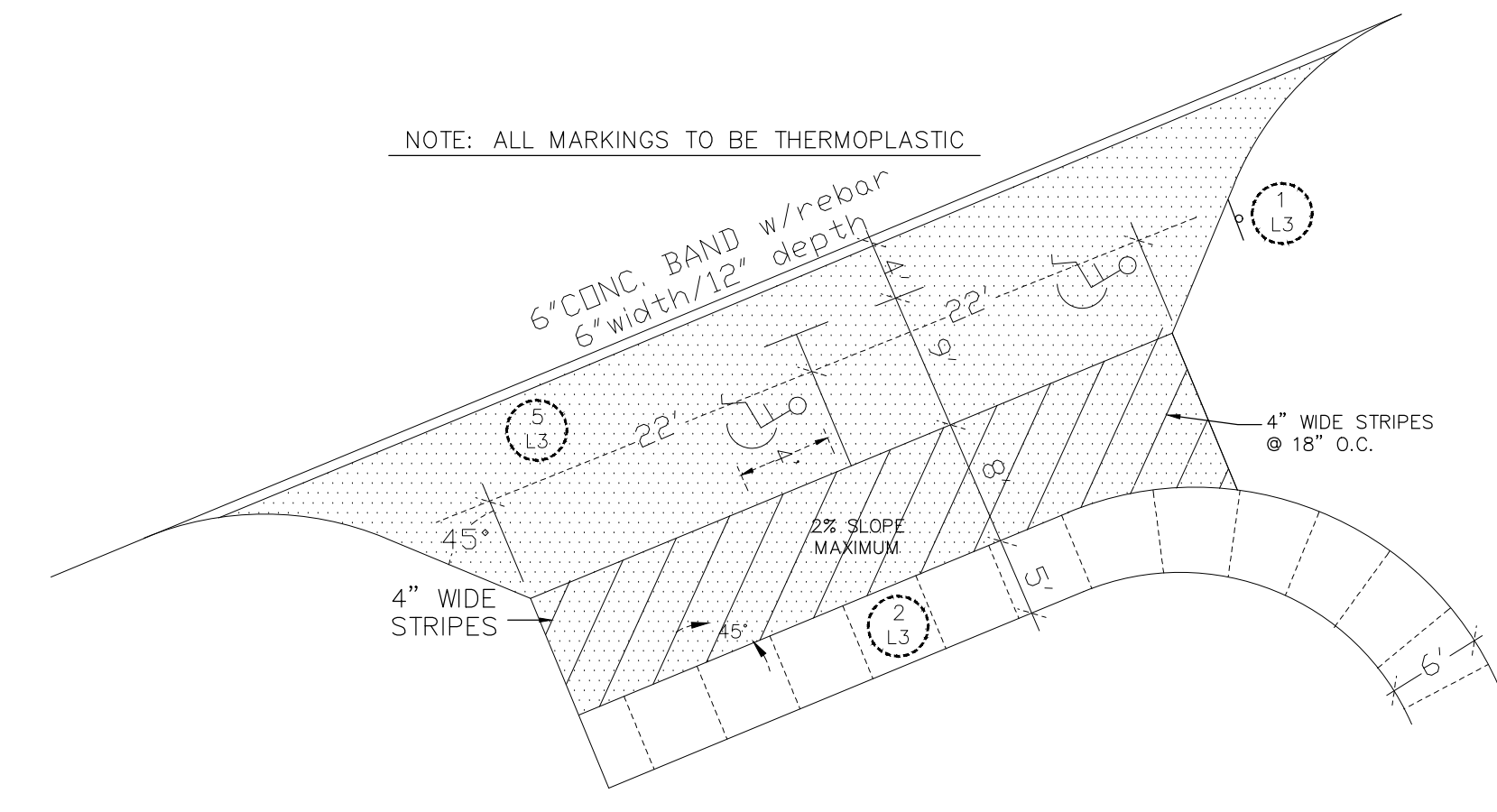

HANDICAP PARKING DETAIL
NOT TO SCALE

4
L3

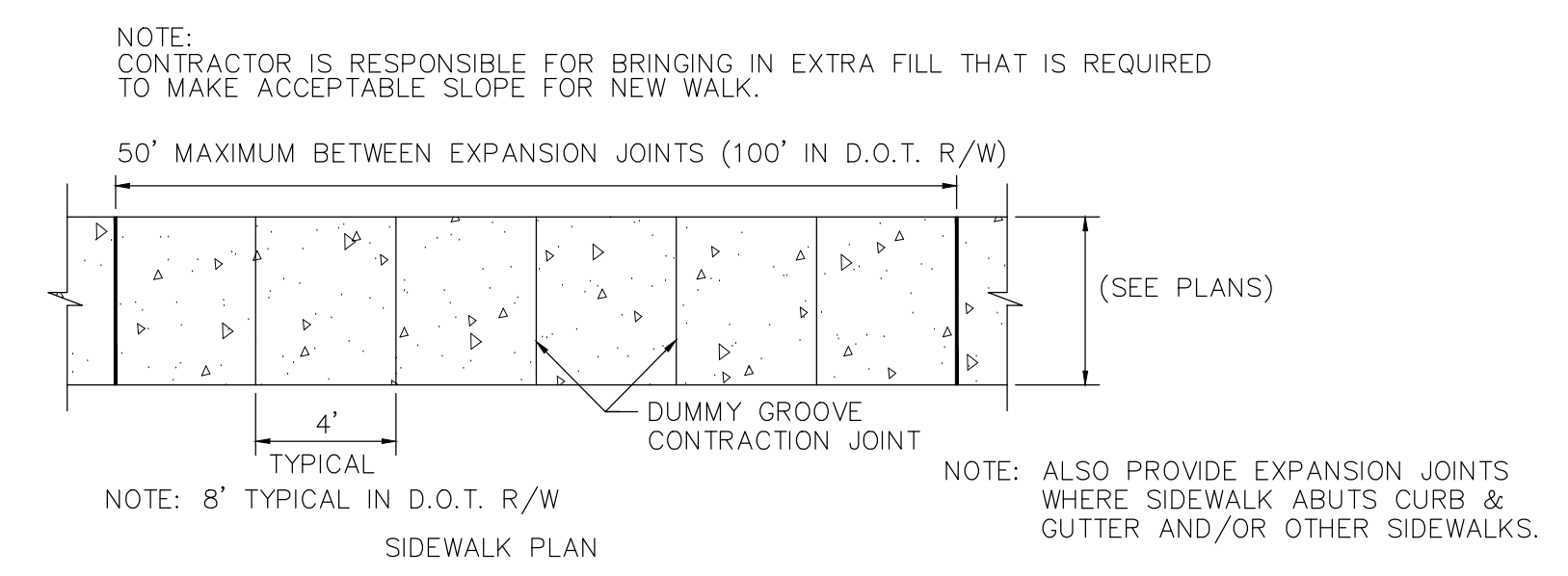

PERVIOUS CONCRETE SIDEWALK
NOT TO SCALE

2
L3

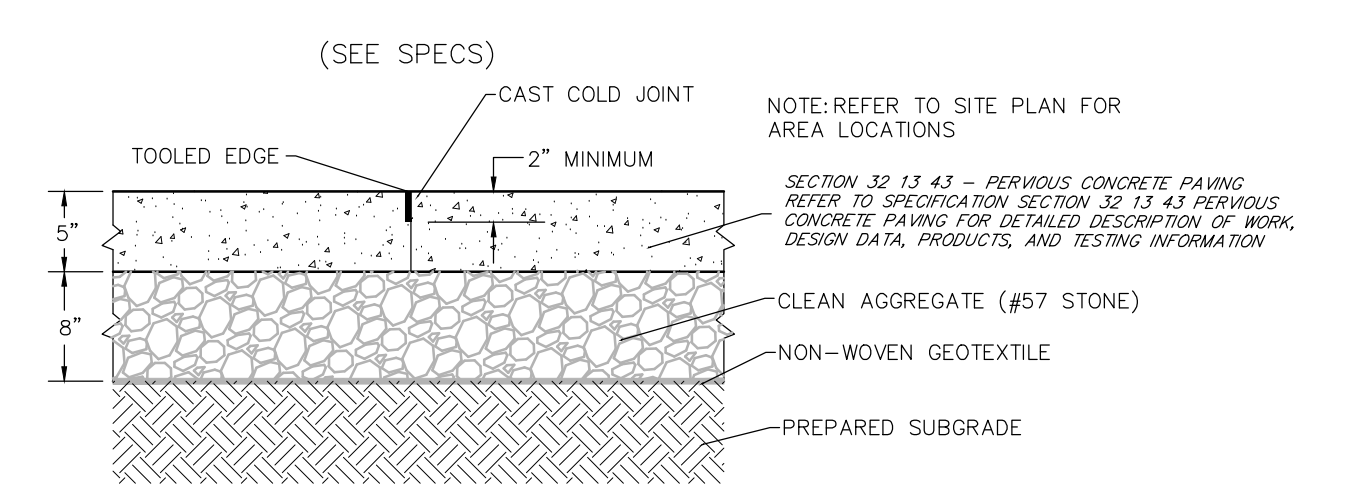

TYPICAL PAVEMENT SECTION
WITHIN SCDOT R/W
NOT TO SCALE

5
L3

- SCDOT NOTES
- 1) ANY FIELD CHANGES WITHIN SCDOT RIGHT OF WAY OR CHANGES THAT WOULD IMPACT SCDOT RIGHT OF WAY WILL REQUIRE WRITTEN SCDOT APPROVAL PRIOR TO CHANGES BEING IMPLEMENTED IN THE FIELD.
 - 2) UTILITY COMPANIES MUST SUBMIT UTILITY ENCROACHMENTS UNDER SEPERATE PERMITS FOR NEW CONNECTIONS OR RELOCATIONS OF EXISTING SERVICES. NO UTILITY WORK CAN BEGIN WITH RIGHT OF WAY WITHOUT AN APPROVED SCDOT ENCROACHMENT PERMIT FOR EACH UTILITY. UTILITY ENCROACHMENT APPROVAL WILL BE HELD UNTIL THE COMMERCIAL PROJECT IS APPROVED. SCDOT WILL NOT ALLOW AN OPEN CUT OF A STATE ROAD IF IT WAS RECENTLY RESURFACED.
 - 3) CONTRACTOR IS TO REFER TO THE MOST CURRENT EDITION OF THE SCDOT STANDARD DRAWINGS FOR WORK PERFORMED WITHIN THE SCDOT RIGHT OF WAY.
 - 4) ALL SIGNS LOCATED IN SCDOT RIGHT OF WAY SHALL BE A U-CHANNEL POST AND BREAK AWAY DESIGN IN ADDITION TO MUTCD.

Revision:	Date:
.	12/13/21
.	5/18/22
.	6/3/22
.	6/16/22